

INSTALLATION AND OPERATING INSTRUCTIONS

安裝使用說明書

Thermo Ventilator 浴室換氣暖風機

Model No. 40BECH
型號：40BECH

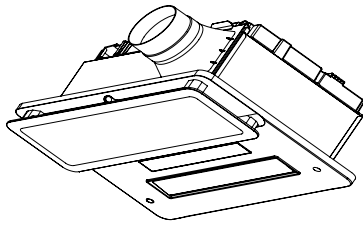

CONTENTS

SAFETY INSTRUCTIONS	2
INSTALLATION INSTRUCTIONS	2~4
INSTALLATION REQUIREMENTS	5~6
SUPPLIED ACCESSORIES	6
PART NAMES AND DIMENSIONS	7
WORK BEFORE INSTALLATION	7~8
HOW TO INSTALL	8~16
TEST RUN	17
FUNCTION OF REMOTE CONTROL	17
HOW TO USE AIR DIRECTION AND AIR TYPE FUNCTION	18
HOW TO USE TIMER FUNCTION	19
HOW TO USE HEATING FUNCTION	20
HOW TO USE VENTILATION FUNCTION	21
HOW TO USE DRYING FUNCTION	21
CARE MODE:	
HOW TO USE WARM BATH FUNCTION	22
HOW TO USE DRY CLOTH FUNCTION	23
HOW TO USE REFRESH FUNCTION	24
HOW TO USE 24HR VENT. FUNCTION	24
MODE BUTTON PANEL ON MAIN BODY	25
USE AND MAINTENANCE INSTRUCTIONS	26~27
MAINTENANCE	28~29
WIRING DIAGRAM	29
TROUBLESHOOTING	30
ANTIBACTERIAL FUNCTION	30
SPECIFICATIONS	31
CHECKS AFTER INSTALLATION	BACK COVER

目錄

安全指引	2
安裝注意事項	2~4
安裝要求	5~6
包裝附件清單	6
部件名稱和尺寸	7
安裝前事項	7~8
安裝方法	8~16
試運轉	17
遙控器功能介紹	17
風向及風種功能的使用方法	18
定時功能的使用方法	19
暖氣功能的使用方法	20
換氣功能的使用方法	21
乾燥功能的使用方法	21
貼心模式：	
溫暖沐浴功能的使用方法	22
高效乾衣功能的使用方法	23
極速排氣功能的使用方法	24
24小時換氣功能的使用方法	24
機體模式按鈕面板	25
使用及維護注意事項	26~27
維護方法	28~29
電氣原理圖	29
常見故障的識別與處理	30
抗菌功能	30
規格	31
安裝後檢查	末頁

Thank you for purchasing this KDK product.

Please read these instructions carefully before attempting to install, operate or service the KDK product. Please carefully read "INSTALLATION INSTRUCTIONS" (P.2~4) of this instructions before installation. Failure to comply with instructions could result in personal injury or property damage. Please explain to users how to operate and maintain the product after installation, and this booklet should be presented to users. Please carefully read "USE AND MAINTENANCE INSTRUCTIONS" (P.26~27) of this instructions before operation.

Please retain this booklet for future reference.

感謝您選用KDK產品。

安裝、使用和保養KDK產品前，請仔細閱讀本安裝使用說明書。安裝前，請務必先閱讀“安裝注意事項”(第2~4頁)。不遵照此說明書進行操作有可能導致人員受傷或財產損失。

安裝完成後，請向顧客說明如何使用和維護KDK產品，並將此說明書交給顧客保管。

使用前，請務必先閱讀“使用及維護注意事項”(第26~27頁)。

請妥善保管好此說明書以備日後參考。

- Disconnect power supply before maintenance.
維護保養前先斷電。
- This appliance is not intended for use by persons (including children) with reduced physical, sensory or mental capabilities, or lack of experience and knowledge, unless they have been given supervision or instruction concerning use of the appliance by a person responsible for their safety. Children should be supervised to ensure that they do not play with the appliance.
本產品不適合有殘疾、智障或精神障礙的人士或缺乏經驗、常識者(包括兒童)維護使用，除非在負責他們安全的人士的看護或指導下使用。兒童應該有人進行看護，以防將產品當做玩具。

The following instructions should be strictly observed in order to prevent injury to the users and other people, or damage to property.

為避免給您及其他人造成傷害，這裡我們列出了以下安全注意事項，請務必遵守，各種標誌的含意請參見以下內容。

- The degrees of injury or damage that can occur when the instructions are ignored and if the product is not used properly have been classified and described by the following indications.

對無視表示內容，錯誤地使用時，會引起的危害或損傷的程度，用下列符號進行分類、說明。



WARNING
警告

This indication means: Must be treated seriously that this may result in death or serious injury.

本標誌所表示內容為“不遵守的話可能造成人員死亡或重傷”。



CAUTION
注意

This indication means: Must be treated seriously that this may result in injury or physical damage.

本標誌所表示內容為“不遵守的話可能造成人身輕傷或其他財產損害”。

- Types of instructions that should be observed have been classified and described by the following pictorial symbols.

對希望遵守的內容和種類，用下列符號進行分類、說明。



This symbol indicates the item is “PROHIBITED” to do.

此標誌表示為禁止事項



This symbol indicates the “COMPULSORY” item that must be followed without failure.

此標誌表示為強制事項



This symbol indicates the item is “CAUTION”.

此標誌表示為提示注意事項

INSTALLATION INSTRUCTIONS

安裝注意事項



WARNING
警告

- The product must be grounded.
必須接地。

- Make sure the power cord is installed firmly.

確保電源線安裝到位。



Otherwise, it may cause electric shock when there is any trouble or electric leakage.
否則當出現故障或漏電時，可能會觸電。



Otherwise, a fire may be caused.
否則可能會導致火災。



WARNING 警告

- Disconnect power source before working on the product.

安裝、維修保養時必須斷開電源。



Otherwise, an electric shock may be caused.

否則可能會導致觸電。

- The product is installed so that switches cannot be touched by a person in the bath or shower.

產品的安裝，應使得浴缸內或淋浴區的人不能夠觸及到開關。



Otherwise, an electric shock may be caused.

否則可能會導致觸電。

- Installation and wiring should be done by authorized person. (Wiring is required to follow the local wiring regulations.)

安裝及電源佈線必須由專業人員完成。(產品安裝必須符合當地的安全法規。)



Otherwise, a fire may be caused.

否則可能會導致火災。

- To avoid danger arising from wrong resetting of the thermal circuit breaker, the product can not be powered by using an external switch. For example, by a timer or connecting to a circuit that is connected/disconnected through timing of a universal part.

為避免由熱斷路器的誤復位產生危險，產品禁止通過外部開關裝置供電。例如，定時器或者連接到由通用部件定時進行通、斷的電路。



Otherwise, a fire may be caused.

否則可能會導致火災。

- Do not install the product near curtains and other flammable materials.

禁止靠近窗簾和其他可燃材料安裝。



Otherwise, combustibles may be inflamed.

否則可能會引燃可燃物。

- Please install a suitable all-pole switch which the contact separation is more than 3 mm. Please install the all-pole switch out of the bathroom where it is easily controlled.

安裝時，須在供電線路中安裝其觸點開距不小於3 mm的“電源全極開關”，以用於接通或斷開主機電源，且安裝在浴室外側方便操作的地方。



Otherwise, it may cause a short circuit, thus resulting a fire.

否則可能會導致短路，導致火災。

- Do avoid the back-flow of gas into the room from the open flue of flammable gas or other open-fire appliances.

必須避免易燃氣體從敞開的氣道或其他燃燒燃料的設備回流進室內。



Otherwise, a fire may be caused.

否則可能會導致火災。

- Please select 60227 IEC 53(RVV) ordinary polyvinyl chloride sheathed cord. Nominal cross-sectional area of conductors is $3 \times 1.5 \text{ mm}^2$.

電源線請選用60227 IEC 53(RVV)型軟線，電源線導線的截面積為 $3 \times 1.5 \text{ mm}^2$ 。



Otherwise, it may be on fire.

否則可能會導致起火。

- Do not install the product as the method which is not approved in the instruction.

禁止使用本說明書指定以外的方法進行安裝。



Otherwise, unreliable installation may be caused and thus the product may fall off, resulting in injuries.

否則可能會安裝不牢固，導致產品掉落受傷。

WARNING 警告

- The product can not be located just below a power outlet socket.

禁止把本產品安放在電源插座下使用。

 Otherwise, a fire may be caused.
否則可能會導致火災。

- Do not operate the product other than the rated voltage (220 V ~ 50 Hz).

禁止使用額定電壓(220 V ~ 50 Hz)以外的電壓。

 Otherwise, it may cause damages to the product or a fire.
否則可能會損壞本產品或導致火災。

CAUTION 注意

- Do not reconstruct this product.

禁止對本產品進行改造。

 Otherwise, it may cause damage to the product or personal injury.
否則可能會導致產品損壞或受傷。

- Do fix this product tightly.

機體安裝必須牢固。

 Otherwise, it may fall off to cause personal injury.
否則可能會掉落，導致受傷。

- Components must be installed tightly.

部品安裝必須牢固。

 
Otherwise, it may fall off to cause personal injury.
否則可能會掉落，導致受傷。

- The special-purpose or dedicated parts, such as mounting fixtures, must be used if such parts are provided.

有安裝五金件等專用零部件時，應使用專用零部件。

 Otherwise, it may fall off to cause personal injury.
否則可能會掉落，導致受傷。

- The building structure and suspender which are used to installed product must have sufficient installation strength and support more than 5 times weight of the product. They must be reinforced if their strength can not be sure.

安裝產品的建築結構和吊桿必須要有足夠的安裝強度，確保有能承載大於產品重量5倍的強度。如不能確保安裝強度，請務必採取加固措施。

 Otherwise, it may fall off to cause personal injury.
否則可能會掉落，導致受傷。

- Please ensure two persons perform the installation of the product.

請兩人進行產品的安裝作業。

 Otherwise, it may fall off to cause personal injury.
否則可能會掉落，導致受傷。

- Install this product over 2.3 m above the floor.

產品安裝高度距地面必須大於2.3 m。

 
Avoiding any accidents
防止意外

INSTALLATION REQUIREMENTS

安裝要求

- Do not form the duct as shown below:

安裝管道應該避免以下情況：

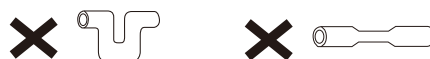

- Do not install onto slanting ceiling board. Do not install the product in places with high temperature.

請勿安裝在傾斜的天花板上。

請勿安裝在高溫的環境下。

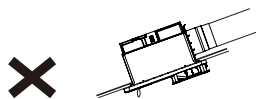

Prevent the water condensed in the duct pipe flow back into the body.

防止水倒流。

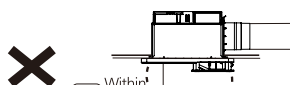

Within 50 cm
50 cm 以內

Ambient temperature above 40 °C.
周圍溫度 40 °C 以上

- Do not install the product in steam sauna bathroom.

請勿安裝在桑拿蒸氣浴室中。



- Do not install the product in the places where the organic solvent is used.

請勿安裝在使用有機溶劑的場所。



- Do not install the product in the places where the sprayer is used.

請勿安裝在使用噴霧器的場所。

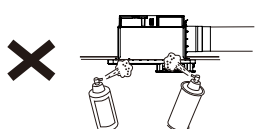

- Do not install the product where it is exposed to oil mist.

請勿安裝在油煙過多的場所。

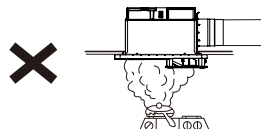

- Please make sure the product is installed horizontally and the deviation angle within the range as below figure.

請確保整機水平安裝偏差角度在 $\pm 2^\circ$ 之間。

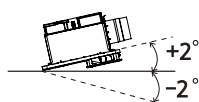

- Please set ventilation holes.

請設置通風口。

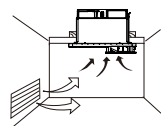

- Please install on a flat ceiling board.

請安裝在平整的天花板上。

- Do not install this product in a public bath room.

請勿把本產品安裝在公共浴室。

- Do not install this product in a wardrobe.

請勿把本產品安裝在衣櫃內。

- The pipe for hanging clothes should be installed at the position of 250 mm apart from the product, please see P.23 for details.

掛衣用管的安裝應距離產品250 mm，詳細請參考第23頁。

- When the ceiling board is unable to dismantle, please set a square inspection hole of at least 45 cm (The inspection hole should not be directly under the duct pipe).

吊裝且天花板無法拆下時，請設置一個邊長45 cm以上的方形點檢口（點檢口不能在管道正下方）。

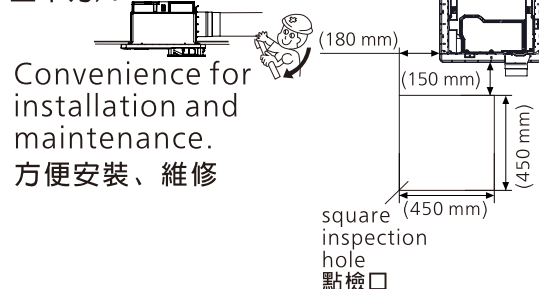

INSTALLATION REQUIREMENTS

安裝要求

- The product is not provided with power cord, all-pole switch and leakage protection switch. Please purchase them in market.
本產品沒有提供電源線，電源全極開關和漏電保護開關，需用戶另購。
- When you install plastic part, do not exert too much strength to fixing the screw, otherwise, the product would be damaged.
安裝塑料部件時，為了不損壞產品，鎖螺絲時請注意不要用力過大。

SUPPLIED ACCESSORIES

包裝附件清單

No. 代號	Drawing 圖樣	Name and Purpose 名稱及用途	Qty 數量
①		Machine screw (M4×8, used to fix the louver and the main body) 機械螺絲(M4×8用於面板與機體固定)	4
②		Machine screw (M4×10, used to install the louver assembly) 機械螺絲(M4×10用於面板組合安裝)	2
③		Self-tapping screw (φ4×20, used to install the main body and the adapter)(for installation method 1 only (P.9)) 自攻螺絲(φ4×20用於機體及出風口接頭的安裝)(只適用於安裝方法一(第9頁))	1
④		Self-tapping screw (φ4×16, used to install the controller holder) (placed on the backside of controller holder) 自攻螺絲(φ4×16用於遙控器底座安裝)(放置於遙控器底座背面)	2
⑤		Self-tapping screw(φ4×8, used to install the adapter and prevent the main body from falling) 自攻螺絲(φ4×8用於出風口接頭的安裝及機體防跌落)	1
⑥		Self-tapping screw (φ4×13, used to install the main body and the suspension bracket) 自攻螺絲(φ4×13用於機體與懸吊支架的安裝)	3
⑦		Product warranty registration 產品保修登記	1
⑧		Installation and operating instructions 安裝使用說明書	1
⑨		Adapter 出風口接頭	1
⑩		Louver assembly 面板組合	1
⑪		Remote control assembly 遙控器組合	1
⑫		R03(AAA) Carbon battery R03(AAA)炭性電池	2
⑬		Suspension bracket 懸吊支架	3
⑭		Installation cardboard 安裝用紙板	1

PART NAMES AND DIMENSIONS

部件名稱和尺寸

Unit: mm 單位: mm

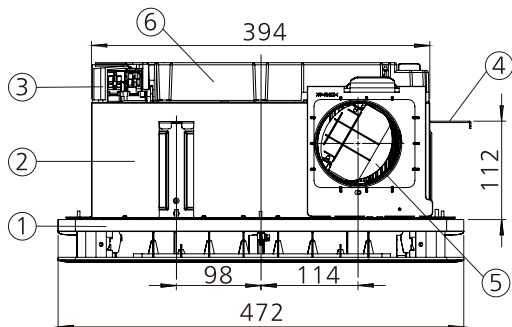

No. 序號	Part name 部件名稱	No. 序號	Part name 部件名稱
①	Louver assembly 面板組合	⑨	Mode button panel on main body 機體模式按鈕面板
②	Main body 機體	⑩	Heater assembly 加熱器組合
③	Cord cover 接線蓋板	⑪	Baffle plate 導風板
④	Suspension bracket 懸吊支架	⑫	Screws cover 螺絲蓋
⑤	Shutter 高氣密性擋片	⑬	Circulation fan 循環扇葉
⑥	PCB cover 電路板蓋板	⑭	Filter assembly 過濾網組合
⑦	Adapter 出風口接頭	⑮	Remote control 遙控器
⑧	Ventilation fan 換氣扇葉	⑯	Controller holder 遙控器底座

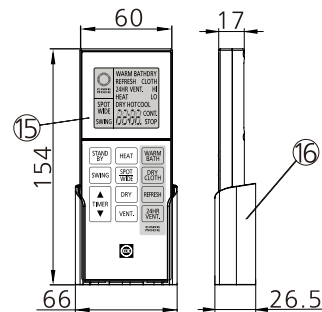
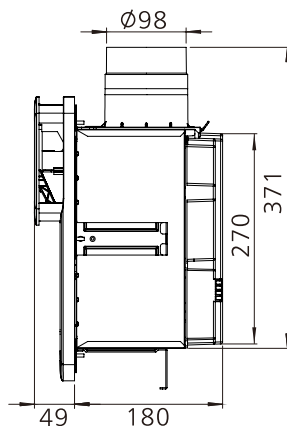
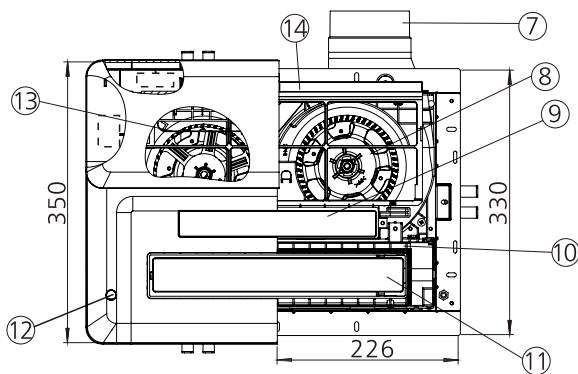

WORK BEFORE INSTALLATION

安裝前事項

1. Confirmation before installation 安裝前確認事項

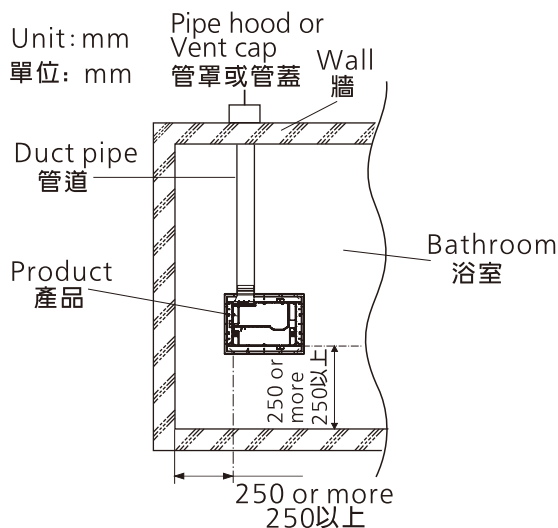

Notice 提示事項

- The distance from louver assembly to walls is 250 mm or more.
面板組合至牆壁的距離在250 mm以上。
- When the ceiling mounting hole is adjacent to curtains or other flammable materials, more than 200 mm from curtains and other flammable materials.
天花板安裝孔鄰近窗簾和其它易燃材料時，離窗簾和其它易燃材料距離200 mm以上。
- The distance between ceiling board where the product is mounted and ceiling shall be over 200 mm.
用於安裝本產品的天花板離房屋頂部的距離在200 mm以上。
- Please reserve a sufficient length of the power cord for easy installation.
電源線請預留足夠的長度，以便於安裝。
- When duct pipe is connected to outside of the room, a vent that diameter is $\phi 110$ mm should be opened. (Duct pipe, pipe hood or vent cap are not supply.)
管道通向室外，須開直徑為 $\phi 110$ mm 牆壁通風孔。(須另購管道、管罩或管蓋)

WORK BEFORE INSTALLATION

安裝前事項

2. Preparation before installation

安裝前準備

Install an all-pole switch with the contact separation not less than 3 mm and specifications not lower than 250 V~16 A and a leakage protection switch (with the leakage current lower than 30 mA) between the fixed wiring and the main body of this product.

請於固定佈線與本產品主機間安裝觸點開距不小於3 mm的“電源全極開關”(規格必須不低於250 V~16 A)及漏電保護開關(洩漏電流在30 mA以下)。

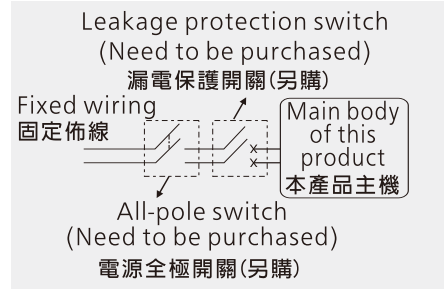

HOW TO INSTALL

安裝方法

1. Main body installation

Method 1 Ordinary ceiling board mounting

- ① Open a 280 mm x400 mm mounting hole in the ceiling board.
在天花板上開一個280 mm x400 mm的安裝孔。
- ② Position and install the suspenders(M8 or M10 suspenders need to be purchased).
吊桿的定位安裝(另購M8或M10)。
- (1) Taking out the installation cardboard from the accessory package, align the four corners of the opening with those of the installation cardboard, and then paste the installation cardboard onto the ceiling.
將產品附帶的安裝用紙板的四角與天花板開口部的四角對齊後,將紙板貼於水泥板上。
- (2) Fix the suspenders on the ceiling according to the location holes as shown in the installation cardboard.
按照安裝用紙板所示的吊桿固定位置,將吊桿固定於水泥板上。

Notice 提示事項

After fixing the suspenders, please rip off the installation cardboard.
吊桿固定完成後請將安裝用紙板撕掉。

- ③ Install the suspension brackets.
懸吊支架的安裝。
- (1) Fix the suspension brackets to the suspenders.
將懸吊支架固定於吊桿。
- (2) Adjust the nut on the suspenders to make the suspension bracket bottom cling to the ceiling board.
調整吊桿上的螺母,使懸吊支架的底部緊貼天花板。

Notice 提示事項

Make sure that the suspension bracket bottom clings to the ceiling board; otherwise the main body cannot be installed successfully.

懸吊支架的底部務必要緊貼天花板,否則可能會導致機體無法安裝。

機體的安裝 方法一 普通天花板吊裝

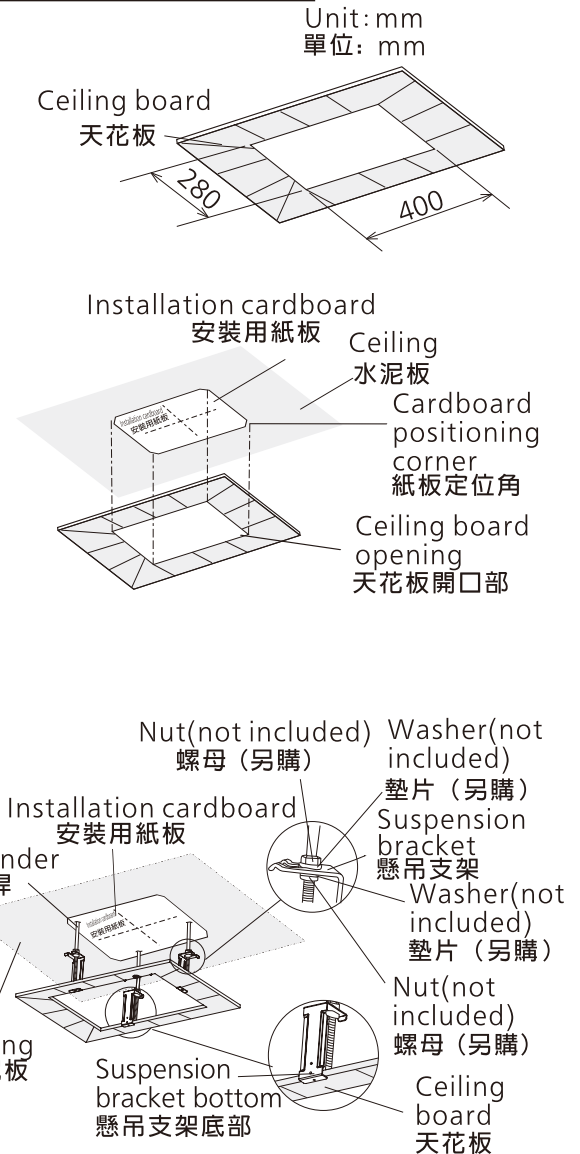

HOW TO INSTALL

安裝方法

- ④ Use the supplied $\phi 4 \times 20$ self-tapping screw to fix the adapter to the ceiling board. (The adapter must fix to the ceiling edge.)
用附件包所提供的1顆 $\phi 4 \times 20$ 自攻螺絲，將出風口接頭固定於天花板上。（接頭必須緊貼天花板邊緣）
- ⑤ Connecting the duct pipe \rightarrow Refer to Section 3. Duct Pipe Connection on P. 15.
連接管道。 \rightarrow 參考第15頁 3. 管道的連接
- ⑥ Connecting power cord.
電源線的連接。

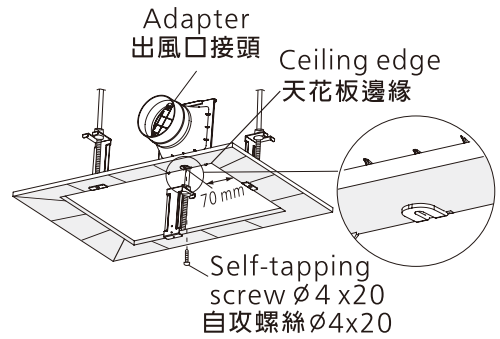

WARNING 警告

-  To avoid electric shock or fire, do not remove the PCB cover.
安裝和使用時禁止拆卸電路板蓋板，否則可能會導致觸電或起火。
-  Please select 60227 IEC 53(RVV) ordinary polyvinyl chloride sheathed cord. Nominal cross-sectional area of conductors is $3 \times 1.5 \text{ mm}^2$.
電源線請選用60227 IEC 53(RVV)型軟線，電源線導線的截面積為 $3 \times 1.5 \text{ mm}^2$ 。
-  For the stripping length, please prepare according to the wiring sketch (refer to figure 1). If the stripping length is too long, it may cause short circuit.
剝線長度，請按照剝線示意圖(右圖1)進行剝線，如剝線過長，可能會導致產品短路。
-  Do not damage the sheath of the power cord, otherwise an electric shock or short circuit may be caused.
電源線的絕緣膠不能破損，否則可能會導致觸電或短路。
-  Strand the core wire together after stripping, then insert them into about 8 mm deep position of the terminal block, ensuring that the part is under the spring slice, and no copper core cord is exposed outside. Make sure that the copper core cords are fixed by screws reliably (the recommended screw fixing torque is $0.49 \text{ N}\cdot\text{m}$) (See Figure 2). Otherwise an electric shock may be caused.
先將剝線後分散的銅芯線絞合在一起，然後伸入到端子台約8 mm深，並確保其在彈簧片的下方，切勿出現銅線外露現象。螺絲擰緊後，請確保銅線不易鬆脫(建議螺絲鎖緊扭矩為 $0.49 \text{ N}\cdot\text{m}$)，否則可能會導致觸電。(右圖2)

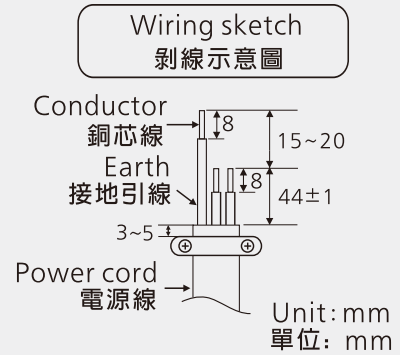

Figure 1
圖1

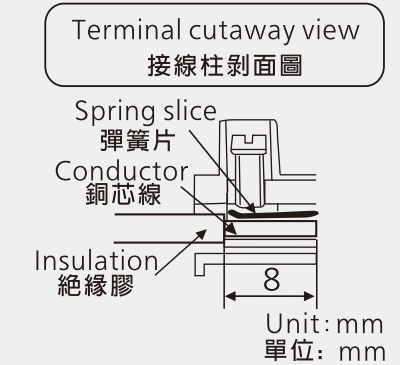

Figure 2
圖2

HOW TO INSTALL 安裝方法

- ⑥-1 Open the cord cover.
 (1) Remove the screw on the cord cover.
 (2) Open the cord cover.
 (3) Lift the terminal cover (Do not remove the terminal cover).

打開接線蓋板

- (1) 取下接線蓋板上的螺絲。
 (2) 打開接線蓋板。
 (3) 掀起端子保護蓋（請不要拆下此保護蓋）。

Terminal cover
 (Do not remove this cover)

PCB cover
 電路板蓋板

端子保護蓋
 (請不要拆下此保護蓋)

Cord cover
 接線蓋板

Self-tapping screws $\phi 4 \times 8$
 自攻螺絲 $\phi 4 \times 8$

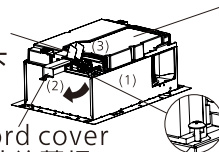

- ⑥-2 Loosen the screws of the cord clip.
 將固定電源線線夾的螺絲鬆脫。

- ⑥-3 Loosen the screws of the pillar terminal, insert the power cord (not supplied) connected to the fixed wiring which in the house into the pillar terminal, tighten the screw.

鬆開接線柱上的螺絲，將接入室內固定線路的電源線（用戶自購）插入接線柱，擰緊接線柱螺絲。

Terminal
 接線柱

Screws
 螺絲

Earth wire
 地線

Cord clip
 線夾

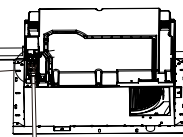
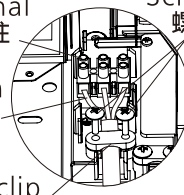

- ⑥-4 Fix the power cord with the cord clip.
 (The cord clip must pin the insulation sheath of power cord.)

用線夾將電源線固定。
 (線夾必須壓住電源線絕緣護套)

Terminal cover
 端子保護蓋

Screws
 螺絲

Cord clip
 線夾

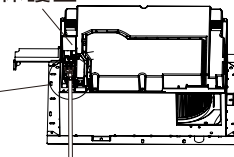
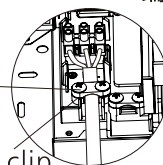

CAUTION
注意

When covering the terminal cover, be sure not to suppress the earth wire, otherwise it may damage the earth wire.

蓋端子保護蓋時，請注意不要壓到地線，否則可能會壓傷地線。

- ⑥-5 Fix the cord cover by the screws which removed by step ⑥-1.

用步驟⑥-1拆下的螺絲，將接線蓋板重新固定。

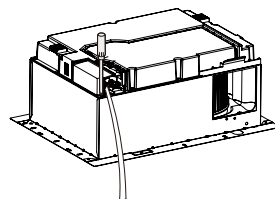

HOW TO INSTALL

安裝方法

- ⑦ Push the main body upward into the ceiling board and wooden frame by closely leaning against the adapter, clip the clipping position of the main body into the locating slot of the adapter (otherwise, it may have air leakage), and fix the main body with three $\phi 4 \times 13$ self-tapping screws.

將機體緊靠出風口接頭往上推入天花板與木框，並使機體上卡位卡入出風口接頭定位槽中(否則漏風)，用3顆 $\phi 4 \times 13$ 的自攻螺絲將機體牢固地固定。



CAUTION 注意

The screws for fixing the main body to the ceiling board should go through the hole of the suspension brackets, otherwise, product may fall down.

固定機體的螺絲，必須通過懸吊支架螺絲孔將機體固定於懸吊支架和天花板，否則產品有掉落的危險。

- ⑧ Use one $\phi 4 \times 8$ self-tapping screw to fix the adapter. Be sure to fix this screw because it can prevent the main body from falling off the ceiling board.

用1顆 $\phi 4 \times 8$ 的自攻螺絲將出風口接頭牢固地固定，此螺絲能起到防止機體脫落的作用，請務必安裝。

- ⑨ After completion of the installation work, be sure the condition between the main body and the adapter is proper. It can be checked from the inspection hole.

安裝完成後，請務必從點檢口確認機體與出風口接頭的安裝是否到位。

Notice 提示事項

If the body and the adapter are not tightly attached, it will cause air leakage and affect the function of preventing the body from falling off in step ⑧.

如機體與出風口接頭未貼緊，會導致漏風，及影響⑧中防止機體脫落的作用。

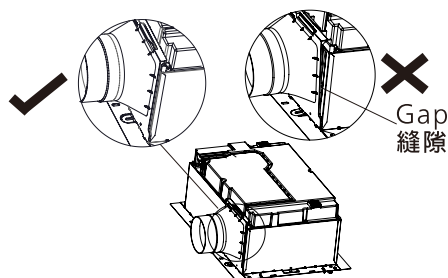
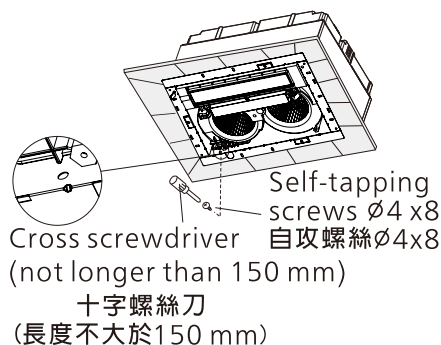
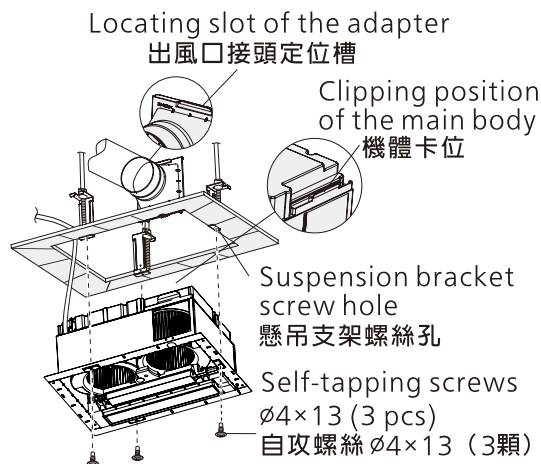

HOW TO INSTALL

安裝方法

1. Main body installation Method 2 Ceiling board has not been installed

機體的安裝 方法二 未裝天花板吊裝

- ① Positioning and installing the suspenders.
吊桿的定位安裝。

Unit: mm
單位: mm

- (1) Paste the installation cardboard provided on the position where the main body is intended to be installed.

將產品附帶的安裝用紙板，黏貼在機體預定安裝的位置。

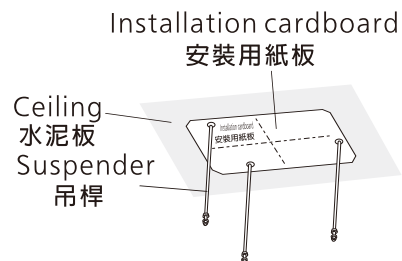

- (2) Fix the suspenders on the ceiling according to the location holes as shown in the installation cardboard.

按照安裝用紙板所示的吊桿固定位置，將吊桿固定於水泥板上。

- ② Fix the adapter to the main body with the $\phi 4 \times 8$ self-tapping screw provided in the accessory package.

用附件包所提供的1顆 $\phi 4 \times 8$ 的自攻螺絲，將出風口接頭固定於機體。

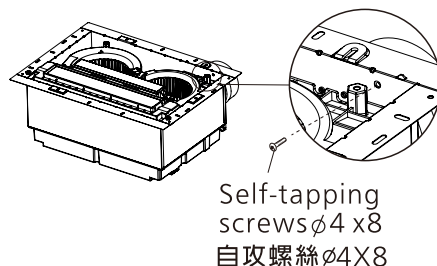

- ③ Fix the suspension bracket to the main body with the $\phi 4 \times 13$ self-tapping screws provided in the accessory package.

用附件包所提供的 $\phi 4 \times 13$ 的自攻螺絲，將懸吊支架固定於機體。

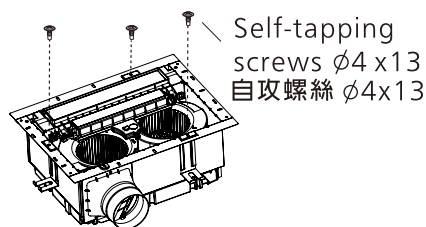

HOW TO INSTALL

安裝方法

- ④ Connecting power cord ➡ Refer to Section ⑥ Power Cord Connection on P.9.
連接電源線 ➡ 參考第9頁 ⑥ 電源線的連接
- ⑤ Fix the main body to the suspenders.
將機體固定於吊桿。
- ⑥ Connecting the duct pipe ➡ Refer to Section 3. Duct Pipe Connection on P.15.
連接管道。 ➡ 參考第15頁 3. 管道的連接
- ⑦ After complete the installation work, please rip off the installation cardboard.
安裝完成後，請將安裝用紙板撕掉。
- ⑧ Install the ceiling board
安裝天花板。

Notice 提示事項

Please install the ceiling board on the upper side of the main body flange.
Otherwise, the louver assembly may not be installed correctly.
天花板請安裝于機體法蘭上側，否則可能會導致面板組合無法正確安裝。

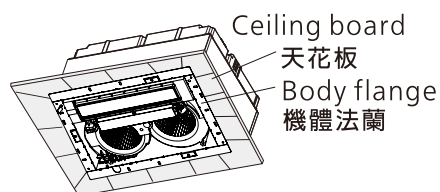
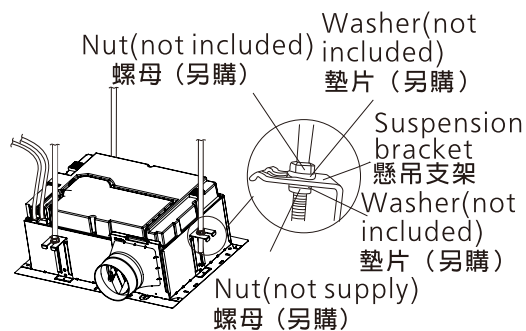

HOW TO INSTALL

安裝方法

2. Installing louver assembly 面板組合安裝

① Remove the filter assembly from the louver assembly.
將過濾網組合從面板組合拆除。

② Open the front panel of the louver assembly by lifting it upward.
將雙層面板的前面板打開，向上掀即可打開。

③ Hang the louver assembly into the hook on the main body.
將面板組合掛入機體上的掛鉤。

④ Insert the screw cover with a slotted screwdriver and pry the screw cover outward. Fix the louver assembly to the main body with four M4×8 machine screws provided in accessory packaging.
用一字螺絲刀插入螺絲蓋的縫隙，往外撬開螺絲蓋。使用附件包所提供的4顆M4×8機械螺絲將面板組合固定於機體。

Notice 提示事項

Please be careful not to scratch the louver assembly.
請注意不要刮花面板組合。

⑤ Covering the screw cover, fix the front panel of louver assembly to louver holder by using the two machine screw M4×10.
將撬開的螺絲蓋重新蓋好，使用2顆M4×10機械螺絲，將面板組合的前面板固定於面板底座。

CAUTION 注意

■ Be sure to fasten the front louver and the louver holder with screws.
務必用螺絲緊固前面板與面板底座。

Otherwise, the front panel may fall and cause injury.
否則前面板可能會掉落導致受傷。

⑥ Install the filter assembly back into the louver assembly.
將過濾網組合重新安裝回面板組合。

Notice 提示事項

1. After finishing installation, make sure that the baffle plate holder protrudes from the louver assembly by approximately 1 mm. Otherwise it may cause the filter assembly to be deformed.
安裝完成後，請確保導風板支架突出面板組合約1 mm。否則可能導致面板組合變形。

2. Make sure that the louver assembly and filter assembly are installed in place, otherwise foreign matter such as dust and hair may enter.
請確保面板組合及過濾網安裝到位，否則可能導致灰塵、毛髮等異物進入。

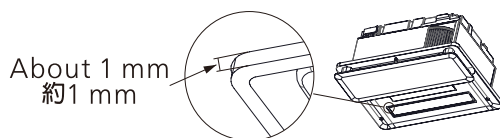
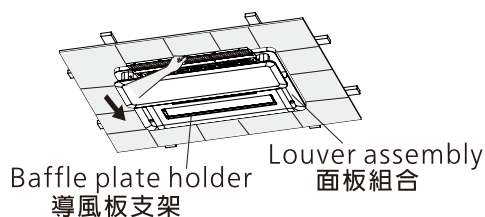
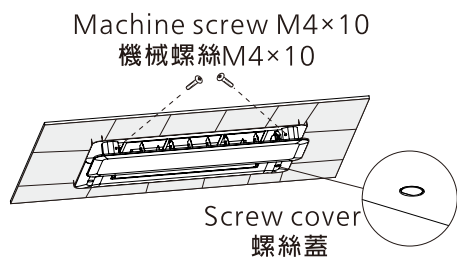
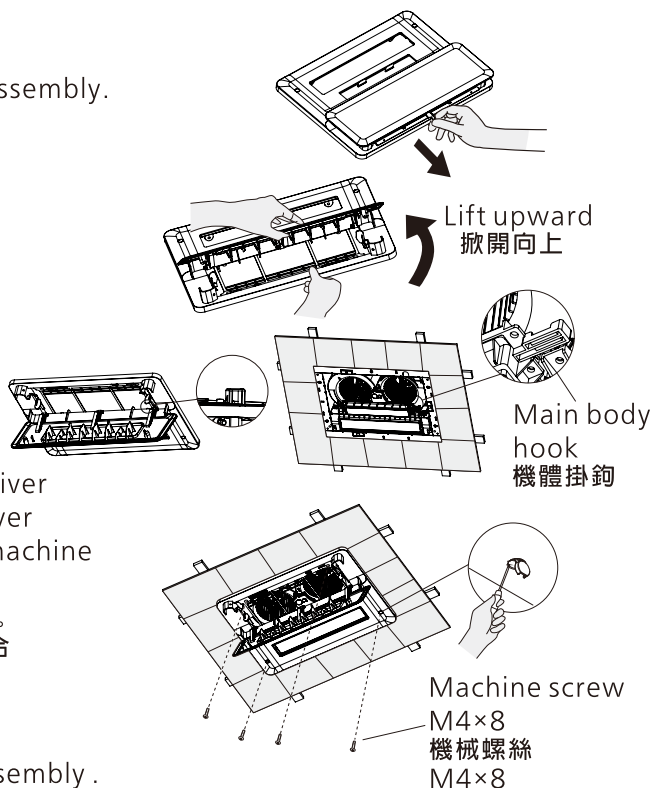

HOW TO INSTALL

安裝方法

3. Connecting duct pipe (Not included) 管道的連接(另購)

- ① Install the duct pipe onto the adapter, and then bind them tightly with adhesive tape. Suspend the duct pipe from the ceiling board to prevent external force exerted on the unit body.

將管道裝入出風口接頭上，然後用膠帶紮緊。
將管道從天花板上懸掛下來，以防止外力施加於機體。

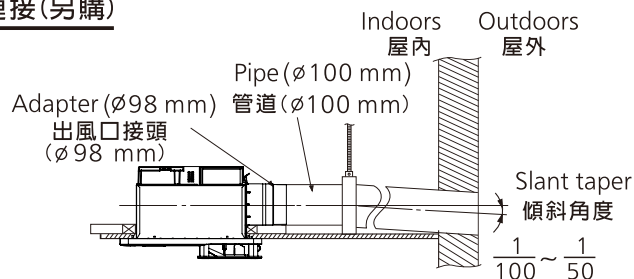

- ② Install the pipe cap or pipe hood on the external wall. (We recommend you purchase products of the following models provided by KDK.)

將管罩或管蓋安裝到屋外。
(建議購買本公司如下所示型號的產品)

Name 名稱	Pipe hood 管罩	Vent cap 管蓋
Model 型號	MCX100K	VCX100K



Notice 提示事項

1. The minimum diameter of the hole: $\phi 110$ mm.
牆壁通風孔最小直徑： $\phi 110$ mm.
2. The duct pipe connected to outside of the room must be slanted to prevent rain or condensed water from flowing backwards.
通往屋外的管道必須保持傾斜，防止雨水或結露水倒流。
3. This duct pipe length should be as moderate as possible. It will affect product performance if it is too long. Total length of the duct pipe should be shorter than 30 m.
管道長度要盡可能適中，過長會影響產品性能，管道最長不要超過30 m。
4. Failure to install a pipe hood or vent cap may result in the entry of birds, insects, rats, etc.
不安裝管蓋或管罩可能造成鳥、蟲、鼠等的進入。

4. Installing the remote control 遙控器的安裝

- ① Take out the remote control from the holder.
把遙控器從遙控器底座抽出。

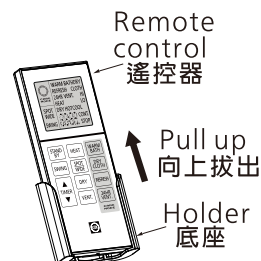

- ② -1 Check the main body can receive the signal from the intended remote control installation location. If remote control can not receive the signal from this installation location, please choose another installation location, or operate the remote control toward product after taking out it from the holder. The installation location cannot be toward the direct spraying area of the shower.
遙控器安裝前，請在預定安裝的位置上檢測機體接收信號的效果，若該位置無法使機體正常接收，請另選擇合適的位置或使用時把遙控器從底座中取出對著機體進行操作。且安裝位置應避免在花灑直淋處。

HOW TO INSTALL 安裝方法

- ②-2 Open two $\phi 6$ holes in the bathroom wall as shown below. And install the controller holder.
在浴室的牆壁上開2顆 $\phi 6$ 的安裝孔，將遙控器底座安裝於牆上。

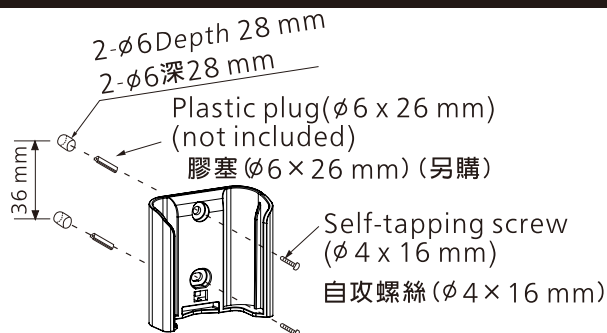

- ③ Install two R03(AAA) carbon batteries in the remote control.
將2粒R03(AAA)炭性電池放入遙控器中。

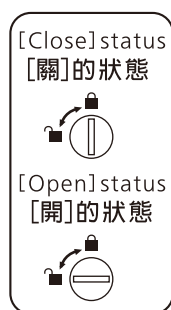

- (1) Rotate the knob "⊕" leftward to the "🔒" position.
將旋鈕⊕向左轉至"🔒"位置

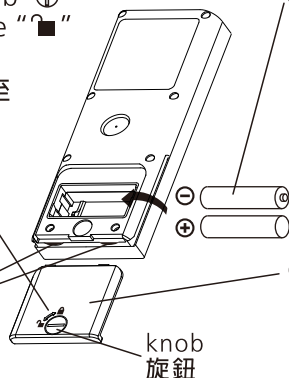

- (3) Install two R03(AAA) carbon batteries in the remote control. (Pay attention to the directions of "⊕" and "⊖")
將兩粒R03(AAA)炭性電池放入遙控器中。(注意⊕, ⊖方向)

- (2) Open the battery cover.
打開電池蓋。

- (4) Replace the battery cover.
重新蓋上電池蓋。

- ④ Please back the remote control to the holder.
將遙控器放回遙控器底座。

- (5) Rotate the knob "⊖" rightward to the "🔒" position.
將旋鈕⊖向右轉至"🔒"位置。



WARNING 警告



Please observe the following when using the batteries.

電池的使用請遵守以下內容。

- Do not inversely install the positive pole and negative pole of batteries.
勿將電池正負反裝。
- Do not short circuit.
不可短路。
(Otherwise, a leakage or damage may be caused.)
(否則可能會導致漏液或破損。)
- Do not use an old battery together with a new battery or use different types of batteries in a mixed way.
勿將新舊、異種電池混合使用。

Notice 提示事項

- If you will not use the remote control for a period of time, take out the batteries.
長期不使用時，請取出電池。
- Do not replace the batteries when the remote control body is wet.
更換電池時，請擦乾遙控器機體後進行更換。
- Do not exert too hard when you rotate the "⊖" knob on the remote control back, otherwise the knob will be damaged.
旋動遙控器背部⊖字旋鈕時，請勿用力過大，否則可能會損壞該旋鈕。
- If the battery cover is not tightened, it will affect the sealing effect.
如果電池蓋未蓋緊，會影響密封效果。

- Please comply with local laws and regulations when dispose the battery.
丟棄電池時，請遵循當地法律法規。

TEST RUN

試運轉

1. After installing, connect the power, press mode button to confirm the product is operated normally and the function is switched properly.

安裝完成後，接通電源，按“模式按鈕”確認產品能正常運轉，功能切換正常。

2. After connecting the power, please check the following item using the remote control:

接通電源，按動遙控器上各個功能按鍵，檢查以下項目：

- Does the fan revolve normally?
扇葉是否正常旋轉？
- Does it have abnormal vibration or noise?
是否有不正常的震動或者噪音？
- Does it blow out hot air?
是否有熱風輸出？
- Is each button on remote control perform its right function?
遙控器上的各個功能按鈕的功能是否正常？

FUNCTION OF REMOTE CONTROL

遙控器功能介紹

STANDBY button 待機按鈕

- In the standby status, this product still requires power consumption of 0.5 W. If the product will not be in use for a long time, the all-pole power switch should be turned off to disconnect the power supply for the purpose of energy saving.

本產品處於待機狀態時，仍有0.5 W的功耗。如長時間不使用時，應使用電源全極開關斷開電源，以節省能源。

- Press and hold the **STANDBY** button for 3 seconds, the product will restore the initial settings.

長按 **STANDBY** 按鈕3秒，產品將恢復初始設置。

SWING button 風向按鈕

Change the air direction
(FIXED/AUTO)
切換風向設置
(固定/自動)

TIMER button 定時按鈕



Increases running time
增加定時運轉時間
Decreases running time
減少定時運轉時間

Air type button 風種按鈕

SPOT: The air is focused in a spot and the speed is high.
“集中”：集中的風種，風比較集中且快速。

WIDE: The air distribution is wide and the speed is low.
“擴散”：擴散的風種，風比較均勻且緩慢。

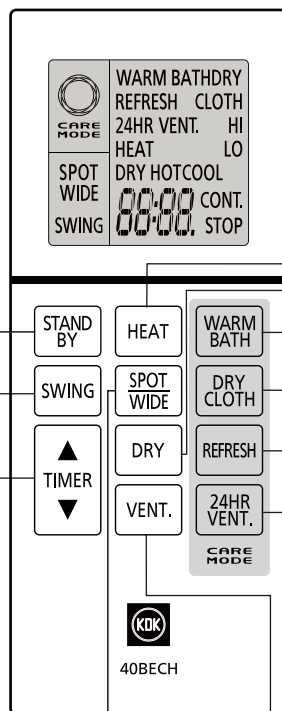

HEAT button 暖氣按鈕

Heating function
暖氣功能

DRY button 乾燥按鈕

Change the dry mode
(COOL/HOT)
切換乾燥方式
(涼乾燥/熱乾燥)

CARE MODE 貼心模式

WARM BATH button 溫暖沐浴按鈕

Warm bath function
溫暖沐浴功能

DRY CLOTH button 高效乾衣按鈕

Dry cloth function
高效乾衣功能

REFRESH button 極速排氣按鈕

Refresh function
極速排氣功能

24HR VENT. button 24小時換氣按鈕

24hr vent. function
24小時換氣功能

VENT. button 換氣按鈕

Ventilation function
換氣功能

HOW TO USE AIR DIRECTION AND AIR TYPE FUNCTION

風向及風種功能的使用方法

SWING

For adjusting air direction
調整風向時使用

During running, you can press the **SWING** button to adjust the air direction.

運轉中可通過 **SWING** 按鈕，調節風向。

- You can press the **SWING** button change the mode between AUTO and FIXED.
通過 **SWING** 鍵，可進行自動與固定的切換。
- Default **HEAT** mode:[FIXED]. Default **DRY** HOT mode and **DRY** COOL mode:[AUTO].
暖氣模式的出廠設置為：[固定]。熱乾燥、涼乾燥模式的出廠設置為：[自動]。
※ FIXED : To fix the baffle plate angle, press the **SWING** button then the baffle plate turns to the required position. The baffle plate will stop.
固定：需固定導風板角度時，待導風板轉到所需位置，按 **SWING** 按鈕，導風板將停止轉動。
- Heating mode will automatically memorize the air direction position set this time.
暖氣模式會自動記憶本次設置的風向位置。
※ To cancel the automatic memory mode, press and hold the **STAND BY** button for 3s.
取消自動記憶模式，請長按 **STAND BY** 按鈕3秒。
- Air direction cannot be set in the **VENT.** mode.
換氣模式不可進行風向設置。

SPOT WIDE

For adjusting air type
調整風種時使用

During running, you can press the **SPOT WIDE** button to adjust the air type.

運轉中可通過 **SPOT WIDE** 按鈕，調節風種。

- Default **HEAT** and HI mode:[SPOT]. Default **HEAT** and Lo mode:[WIDE]
暖氣模式強檔的出廠設置為：[集中]。弱檔為：[擴散]。
- The default **DRY** HOT mode and **DRY** COOL mode is [SPOT (9min) → WIDE (13.5min) → SPOT (9min) ...] switched cyclically.
熱乾燥、涼乾燥模式的出廠設置為[集中(9分鐘) → 擴散(13.5分鐘) → 集中(9分鐘) ...]循環切換。
- Heating mode will automatically memorize the air type position set this time.
暖氣模式會自動記憶本次設置的風種位置。
※ To cancel the automatic memory mode, press and hold the **STAND BY** button for 3s.
取消自動記憶模式，請長按 **STAND BY** 按鈕3秒。
- Air type cannot be set in the **VENT.** mode.
換氣模式不可進行風種設置。

The moving range of the baffle plate for both automatic mode and fixed mode is shown in the table.
自動及固定模式時，導風板具體變動範圍如下表。

	Air direction 風向	Air type 風種	
		SPOT集中	WIDE擴散
HEAT mode 暖氣模式	FIXED 固定	60°~120°	60°~120°
	AUTO 自動	60°⇔120°	60°⇔120°
DRY COOL mode 涼乾燥模式	FIXED 固定	60°~120°	60°~120°
	AUTO 自動	60°~120° ⇔ 60°~120° ※	60°~120°
DRY HOT mode 熱乾燥模式	FIXED 固定	60°~120°	60°~120°
	AUTO 自動	60°~120° ⇔ 60°~120° ※	60°~120°

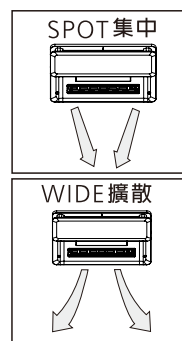
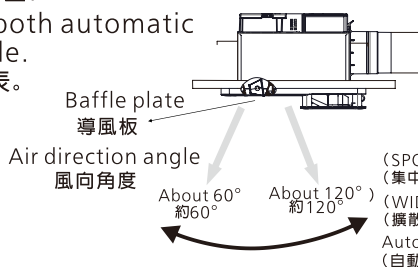

- The ⇔ symbol indicates the automatic circulation running mode.
符號代表自動循環運轉。
- The ※ symbol indicates the rotation range. If the air type **SPOT WIDE** is not set, the air deflector will automatically rotate according to this rotation range.
※ 符號代表轉動範圍，如對風種 **SPOT WIDE** 無設置時，將自動按此轉動範圍進行轉動。

HOW TO USE TIMER FUNCTION

定時功能的使用方法



For adjusting running time
調整運轉時間時使用

During running, you can press the button to change the running time.

運轉中可通過 調整運轉時間。

- ① Each time you press the ▲ button, the time increases accordingly.
每按一次 ▲ 按鈕，時間會隨之遞增；
Each time you press the ▼ button, the time decreases accordingly.
每按一次 ▼ 按鈕，時間會隨之遞減；
If you press and hold the button, the running time keeps changing.
如連續按，運轉時間會連續快速變換。

- ② After the running time is set once, the system will automatically memorize the last running time of each mode.

設置一次運轉時間後，會自動記憶每個模式上一次的運轉時間。

To cancel the automatic memory content, press and hold the button for 3 seconds.

取消自動記憶內容，請長按 按鈕3秒。

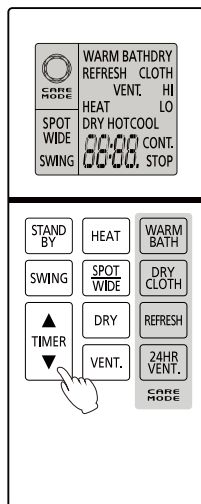

HEAT mode
暖氣模式

5 MIN. ~ 3 HOUR Default settings 出廠設置為 15 MIN.

VENT. mode
換氣模式

5 MIN. ~ 12 HOUR ~ CONT. Default settings 出廠設置為 15 MIN.

DRY HOT mode
熱乾燥模式

5 MIN. ~ 6 HOUR Default settings 出廠設置為 15 MIN.

DRY COOL mode
涼乾燥模式

5 MIN. ~ 12 HOUR ~ CONT. Default settings 出廠設置為 15 MIN.

CARE MODE - WARM BATH mode
貼心模式 - 溫暖沐浴模式

5 MIN. ~ 1 HOUR Default settings 出廠設置為 15 MIN.

CARE MODE - DRY CLOTH mode
貼心模式 - 高效乾衣模式

5 MIN. ~ 6 HOUR Default settings 出廠設置為 15 MIN.

CARE MODE - REFRESH mode
貼心模式 - 極速排氣模式

5 MIN. ~ 1 HOUR Default settings 出廠設置為 15 MIN.

- ※ In the above running mode, each time you press the button, the time changes at the step of 5 minutes; one hour later, the time will change at the step of 30 minutes.

在上記運轉模式中每按一次 按鈕，時間會以5分進行增減，1小時後時間會以30分鐘進行增減。

HOW TO USE HEATING FUNCTION

暖氣功能的使用方法

HEAT

Use when you feel cold in a bath
在浴室中感到冷時使用

Before taking a bath, start the heating function to warm the bathroom beforehand.

在沐浴前開暖氣功能，可提前將浴室升溫。

① Press the **HEAT** button to start the heating mode at the HI.

It will switch to the LO. mode if you press this button again.

按 **HEAT** 按鈕，暖氣模式以強檔開始運轉，再按一次將切換為弱檔。

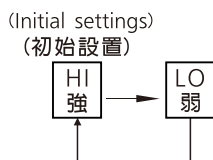

The default [FIXED] is recommended. The air direction can be reset during operation.

推薦使用出廠設置狀態[固定]，運轉中也可以重新設置風向。

The default [SPOT] is recommended. The air type can be reset during operation.

推薦使用出廠設置狀態[集中]，運轉中也可以重新設置風種。

The default setting is 15 minutes. You can adjust it as required.
出廠設置狀態為15分鐘，用戶可根據需要自行調整。

② This product will stop automatically when the set time is up.
運轉完所設置時間後，本機會自動停止。

③ To stop midway in running, press the **STAND BY** button.
如需在運轉途中停止，請按 **STAND BY** 按鈕。

※ In the heating mode running for 30 seconds above, press the **STAND BY** button to stop the heater. The fan will stop running after a delay of 20 seconds.

若在暖氣模式運轉30秒以上，按 **STAND BY** 按鈕後，為使加熱器冷卻，扇葉將延遲20秒停止運轉。

Notice 提示事項

1. Hot startup function: After the product starts up in the high heating mode when the temperature in the bathroom is lower than 20 °C, it enters the hot startup status to avoid blowing of cold air, and the fan runs at a low speed. When the temperature in the bathroom reaches 20 °C or above or after running for 60 seconds, the hot startup status stops and the fan runs at a high speed.

熱啟動功能：當浴室溫度低於20°C時，以暖氣強檔模式啟動後，為避免冷風吹出，產品進入熱啟動狀態，扇葉以低速運轉，待浴室溫度達至20°C以上或經過60秒後，熱啟動狀態停止，扇葉以高速運轉。

2. Heater may stop heating when temperature in bathroom is up to required degree, and may restart heating as the temperature in bathroom cools down.

當浴室內溫度上升到一定程度時，加熱器停止工作，待溫度下降到一定程度後，加熱器重新開始工作。

HOW TO USE VENTILATION FUNCTION

換氣功能的使用方法

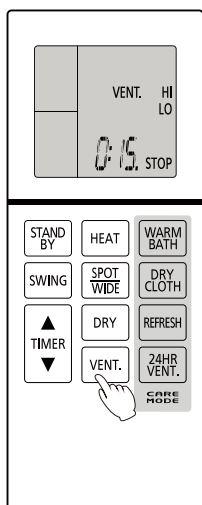

VENT. Use to ventilate the bathroom
浴室換氣時使用

After taking a bath, you can use the **VENT.** function to ventilate the air.
在沐浴後可使用 **VENT.** 功能，進行排氣。

※ If there is too much vapor, the strong mode is suggested.

如蒸汽較多建議使用強檔。

- ① Press the **VENT.** button. The ventilation mode will start at the Hi. When you press the **VENT.** button again, the ventilation mode will switch to the Lo mode.

按一次 **VENT.** 按鈕，換氣模式將以[強檔]開始運轉，再按一次 **VENT.**，將換氣切換為[弱檔]模式運轉。

VENT. Hi or Lo
強或弱

+
TIMER The default setting is 15 minutes. You can adjust it as required.
出廠設置狀態為15分鐘，用戶可根據需要自行調整。

SWING **SPOT WIDE** Cannot be set in the ventilation mode.
換氣模式中不可進行設置。

HOW TO USE DRYING FUNCTION

乾燥功能的使用方法

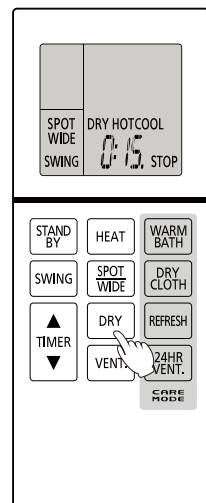

DRY Use when you need to dry the bathroom
乾燥浴室時使用

- ① Press the **DRY** button to start the DRY HOT mode. It will switch to the DRY COOL mode if you press this button again.

按 **DRY** 按鈕，熱乾燥模式開始運轉，再按一次將切換為涼乾燥模式。

(Initial settings)
(初始設置)

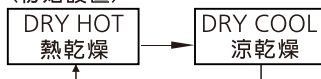

SWING The default [AUTO] is recommended. The air direction can be reset during operation.
推薦使用出廠設置狀態[自動]。運轉中也可以重新設置風向。

+
SPOT WIDE The default mode is [SPOT (9min) → WIDE (13.5min) → SPOT (9min) ...] switches cyclically. The air type can be reset during operation.
推薦使用出廠設置狀態[集中(9分鐘) → 擴散(13.5分鐘) → 集中(9分鐘) ...]循環切換。運轉中也可以重新設置風種。

+
TIMER The default setting is 15 minutes. You can adjust it as required.
出廠設置狀態為15分鐘，用戶可根據需要自行調整。

- ② This product will stop automatically when the set time is up.
運轉完所設置時間後，本機會自動停止。

- ③ To stop midway in running, press the **STAND BY** button.

如需在運轉途中停止，請按 **STAND BY** 按鈕。

※ In the DRY HOT mode running for 30 seconds above, press the **STAND BY** button to stop the heater. The fan will stop running after a delay of 20 seconds.

若在熱乾燥模式運轉30秒以上，按 **STAND BY** 按鈕後，為使加熱器冷卻，扇葉將延時20秒停止運轉。

※ To use the drying function to dry clothes, please install the product as shown in page 23.
使用乾燥功能進行衣物烘乾時，建議按照第23頁的圖進行安裝。

CARE MODE - HOW TO USE WARM BATH FUNCTION

貼心模式 – 溫暖沐浴功能的使用方法

WARM BATH

Use when you feel cold in a bath
在浴室中感到冷時使用

Before taking a bath, start the heating function to warm the bathroom beforehand.

在沐浴前開暖氣功能，可提前把浴室加溫。

- ① Press the **WARM BATH** button to start the heating mode at the HI. It will switch to the VENT. mode at the HI. automatically when the set time is up. After 3 minutes, it will switch to the VENT. mode at the LO. automatically and run continuously.

按 **WARM BATH** 按鈕，溫暖沐浴模式以暖氣強檔開始運轉。運轉至所設時間後自動進入換氣強檔模式，運轉三分鐘後自動進入換氣弱檔模式並連續運轉。

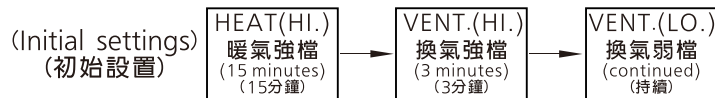

The remote does not display this status time
遙控器不顯示此狀態時間

- ② During running, you can press **TIMER** to change the set time. (After heating, enter the ventilation state, the time is not adjustable.)

運轉過程中，可通過 **TIMER** 調整設置時間。

(暖氣結束後，進入換氣狀態，時間不可調。)

- ③ During operation, you can press the **SWING** button to change the air direction. (After heating, enter the ventilation state and the wind direction is not adjustable.)

運轉過程中，可通過 **SWING** 按鈕，調整風向。

(暖氣結束後，進入換氣狀態，風向不可調。)

- ④ During operation, you can press the **SPOT WIDE** button to change the air type. (After heating, enter the ventilation state and the air type is not adjustable.)

運轉過程中，可通過 **SPOT WIDE** 按鈕，調整風種。

(暖氣結束後，進入換氣狀態，風種不可調。)

- ⑤ To stop midway in running, press the **STAND BY** button.

如需在運轉途中停止，請按 **STAND BY** 按鈕。

- ※ In the heating mode running for 30 seconds above, press the **STAND BY** button to stop the heater. The fan will stop running after a delay of 20 seconds.

若在暖氣模式運轉30秒以上，按 **STAND BY** 按鈕後，為使加熱器冷卻，扇葉將延遲20秒停止運轉。

1. Hot startup function: After the product starts up in the high heating mode when the temperature in the bathroom is lower than 20 °C, it enters the hot startup status to avoid blowing of cold air, and the fan runs at a low speed. When the temperature in the bathroom reaches 20 °C or above or after running for 60 seconds, the hot startup status stops and the fan runs at a high speed.

熱啟動功能：當浴室溫度低於20°C時，以暖氣強檔模式啟動後，為避免冷風吹出，產品進入熱啟動狀態，扇葉以低速運轉，待浴室溫度達至20°C以上或經過60秒後，熱啟動狀態停止，扇葉以高速運轉。

2. Heater may stop heating when temperature in bathroom is up to required degree, and may restart heating as the temperature in bathroom cools down.

當浴室內溫度上升到一定程度時，加熱器停止工作，待溫度下降到一定程度後，加熱器重新開始工作。

CARE MODE - HOW TO USE DRY CLOTH FUNCTION

貼心模式 – 高效乾衣功能的使用方法

DRY CLOTH

Use when you need to dry clothes

乾衣物時使用

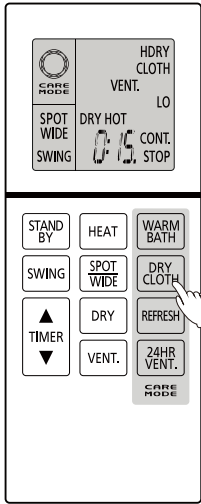

- ① Press the **DRY CLOTH** button to start the DRY HOT mode. It will switch to the VENT. mode at the LO. automatically when the set time is start and keep running.
按 **DRY CLOTH** 按鈕，高效乾衣模式以熱乾燥開始運轉。運轉至所設時間後自動進入換氣弱檔模式並持續運轉。

(Initial settings)
(初始設置)

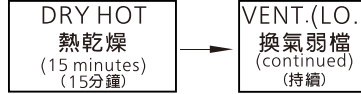

- ② During running, you can press **TIMER** to change the set time. (After the dry hot mode, enter the ventilation state, the time is not adjustable.)

運轉過程中，可通過 **TIMER** 調整設置時間。

(熱乾燥模式結束後，進入換氣狀態，時間不可調。)

- ③ During operation, you can press the **SWING** button to adjust air direction. (After the dry hot mode, enter the ventilation state and wind direction is not adjustable.)

運轉過程中，可通過 **SWING** 按鈕，調整風向。(熱乾燥模式結束後，進入換氣狀態，風向不可調。)

- ④ During operation, you can press the **SPOT WIDE** button to change the air type. The default mode is [SPOT (9min) → WIDE (13.5min) → SPOT (9min) ...] switches cyclically. (After dry hot, enter the ventilation state and the air type is not adjustable.)

運轉過程中，可通過 **SPOT WIDE** 按鈕，調整風種。使用出廠設置狀態[集中(9分鐘) → 擴散(13.5分鐘) → 集中(9分鐘) ...]循環切換。(熱乾燥結束後，進入換氣狀態，風種不可調。)

- ⑤ To stop midway in running, press the **STAND BY** button.

如需在運轉途中停止，請按 **STAND BY** 按鈕。

※ In the dry hot mode running for 30 seconds above, press the **STAND BY** button to stop the heater. The fan will stop running after a delay of 20 seconds.

若在熱乾燥模式運轉30秒以上，按 **STAND BY** 按鈕後，為使加熱器冷卻，扇葉將延遲20秒停止運轉。

※ Heater may stop heating when temperature in bathroom is up to certain degree, and may restart heating as the temperature in bathroom cools down.

當浴室內溫度上升到一定程度時，加熱器停止工作，待溫度下降到一定程度後，加熱器重新開始工作。

※ To use the drying function to dry clothes, you are suggested to install the product as shown below:

使用乾燥功能進行衣物烘乾時，建議按照下圖示進行安裝



Unit: mm
單位: mm

To make the effect of drying clothes better, please set a ventilation shutter at the lower part of the door with a valid opening area of 100 cm² or above.

為使乾衣效果更好，建議在門下部設置有效開口面積應在100 cm²以上的換氣用百葉窗。



WARNING
警告



This appliance is intended only for drying textiles washed in water. Otherwise, it may cause injury.

器具僅用於乾燥水洗的紡織物。否則可能會導致傷害。



CAUTION
注意



Do not leave clothes too close to the air outlet. Otherwise, a fire may be caused.

禁止將衣物離出風口太近。否則可能會導致火災。

CARE MODE - HOW TO USE REFRESH FUNCTION

貼心模式 – 極速排氣功能的使用方法

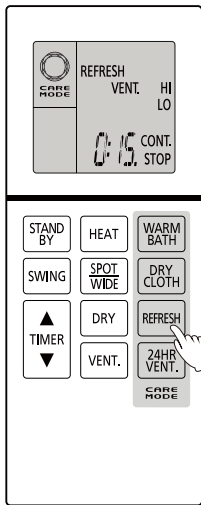

REFRESH

Use to ventilate the bathroom
浴室換氣時使用

- ① Press the **REFRESH** button to start the VENT. mode at the HI. It will switch to the VENT. mode at the LO. automatically when the set time is start and run continuously.

按 **REFRESH** 按鈕，極速排氣模式以換氣強檔開始運轉。運轉至所設時間後自動進入換氣弱檔模式並連續運轉。

(Initial settings)
(初始設置)

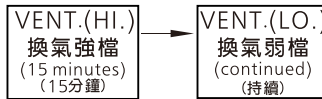

- ② During running, you can press **TIMER** to set the ventilation time.

運轉過程中，可通過 **TIMER** 調整設置換氣強檔時間。

- ③ To stop midway in running, press the **STANDBY** button.

如需在運轉途中停止，請按 **STANDBY** 按鈕。

CARE MODE - HOW TO USE 24HR VENT. FUNCTION

貼心模式 – 24小時換氣功能的使用方法

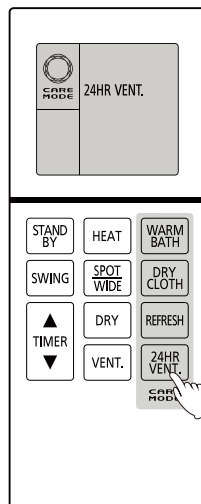

24HR VENT.

Use for ventilate the bathroom continuously
想對浴室持續換氣時使用

- ① Press the **24HR VENT.** button to start the 24HR VENT. mode to ventilate the bathroom continuously.

按 **24HR VENT.** 按鈕，24小時換氣模式開始運轉。

- ② **SPOT WIDE**
SWING
TIMER } Cannot be used in the 24 hour ventilation mode
24小時模式中不可進行設置

- ③ To stop running, press the **STANDBY** button.

如需停止，請按 **STANDBY** 按鈕。

MODE BUTTON PANEL ON MAIN BODY

機體模式按鈕面板

When the remote control is lost or does not work, you can use the MODE button panel on the front surface of the main body to operate the product. (Each time can be operated for 15 mins)
當遙控器丟失或者無法正常使用時，可臨時通過機體面板正面的模式按鈕進行操作。（每次可運轉15分鐘）

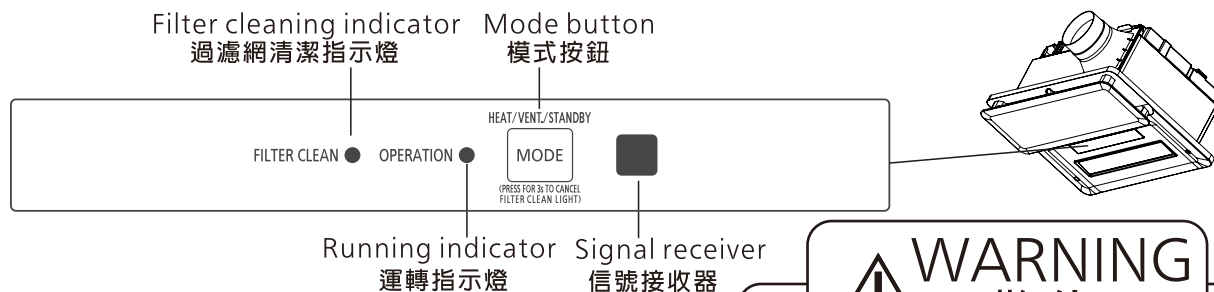

1. The MODE button can be used to switch among the following functions:

模式按鈕可進行下記功能的切換：



WARNING
警告



Do not press the MODE button during a bath or shower in the bathroom. Otherwise, you may slip.
為避免意外滑倒，當在浴室沐浴時，請不要操作模式按鈕。

2. Conditions of the filter cleaning indicator and running indicator.

過濾網清潔指示燈及運轉指示燈的變化。

Run Status 運轉狀態	Filter cleaning indicator 過濾網清潔指示燈	Running indicator 運轉指示燈
Stop 停止	Off 滅	Off 滅
Normal running 正常運轉	Off 滅	On 亮
Abnormal running 運轉異常	Off 滅	Blinking fast ^{※1} 快速閃爍
Normal running 正常運轉 + Filter cleaning indication 過濾網清潔提示	Blinking fast 快速閃爍	On 亮
During the hot startup 熱啟動功能時	Off 滅	Blinking slow ^{※2} 慢速閃爍

The product error means that a fault occurs or the main body fails to operate normally, when the running indicator blinks quickly. Please disconnect the power supply, and contact customer consultation service center or your distributor.

產品異常主要指出現故障或主機失常時，運轉指示燈快速閃爍，請斷開電源，且與客戶諮詢服務中心或經銷商聯繫。

※1 Blinking fast: On for 0.5 seconds and off for 0.5 seconds
快速閃爍：0.5秒亮、0.5秒滅。

※2 Blinking slow: On for 1 second and off for 1 second
慢速閃爍：1秒亮、1秒滅。



WARNING 警告

- Do not disassemble this product for repair or reconstruction.

禁止拆解本產品進行修理或改造。



Doing this may lead to fire and electric shock.

容易導致火災、觸電。

- To avoid low-temperature scalding, do not directly blow the same part of the body with hot wind for a long time (2 hours or above).

請勿長時間(2小時或以上)讓熱風直接吹在身體同一位置。



Doing this may lead to low-temperature scald.

可能會導致低溫燙傷。

- Do not directly spray this product with water and other liquids.

禁止用水及其他液體直接噴射本產品。



Doing this may lead to short circuit or electric shock.

可能會導致短路或觸電。

- Please observe the following when using the batteries.

電池的使用請遵守以下內容。

- Do not inversely install the positive pole and negative pole of batteries. 勿將電池正負反裝。
- Do not use an old battery together with a new battery or use different types of batteries in a mixed way. 勿將新舊、異種電池混合使用。
- Do not short circuit. 不可短路。



Otherwise, a leakage or damage may be caused.

(否則可能會導致漏液或破損)。

- Once flammable gas leaks, do not start any function of this product.

當發生煤氣洩漏時，禁止開啟本產品的任何功能。



Doing this may generate spark and thus lead to explosion.

可能會產生火花而引起爆炸。

- Do not clean the heating part or let water flow into the electric motor or electrical parts.

禁止清潔加熱部件，且切勿讓水進入電動機及電器部件內。



Otherwise, may lead to electric shock.

否則可能會觸電。

- Do not put battery into fire or heat, break, modify it.

禁止將電池投入火中及加熱、分解、改造。



If the insulation or exhaust value is damaged, the battery may become hot, crack.

如損傷了絕緣物或排氣閥等，可能會導致電池漏液、發熱、破裂。

- Do not use battery of broken casing.

禁止使用外皮剝落的電池。



If the insulation or exhaust value is damaged, the battery may become hot, crack.

如損傷了絕緣物或排氣閥等，可能會導致電池漏液、發熱、破裂。

- If the alkaline liquid of battery enter eyes, clean the eyes with lots of water and seek medical help immediately, but not rub eyes with hands.

電池的鹼性液體不慎進入眼內時，切勿用手揉擦眼睛，迅速使用大量清水充分洗淨和醫治。



Otherwise, it may cause blindness, etc.

否則可能會導致失明等。

USE AND MAINTENANCE INSTRUCTIONS

使用及維護注意事項



WARNING 警告

- Do not put the battery in reach of children and infants.

禁止將電池放置在嬰幼兒可觸及到的地方。



If the battery is swallowed, seek medical help immediately.
萬一錯誤吞食，請從速求診。

- If the product will not be in use for a long time, please use the "all-pole power switch" to disconnect the product.

不使用產品時，請斷開產品“電源全極開關”。



Otherwise, may lead to electric shock.
否則可能會觸電。

- If you will not use this product any more, remove the product.

如以後不打算再使用本產品時，不得放置不管，而應予以拆除。



This product may cause injuries once it falls off.
萬一掉落，可能會導致受傷。

- Please promptly take out of the exhausted battery from the remote control.

用完的電池，請及時從遙控器中取出。



Otherwise, battery may leakage or rupture.

如放置不管，有可能會導致電池漏液或發熱、破裂。

- Before touching the main body of this product or cleaning this product, make sure that the "all-pole switch" connected to this product is disconnected.

在接觸本產品機體前和清潔本產品時，必須確保連接本產品的“電源全極開關”處於斷開狀態。



Otherwise, may lead to electric shock.

否則可能會觸電。



CAUTION 注意

- When you clean this product, please wear gloves.

清潔時請帶上手套。



Otherwise, may lead to injury.
否則可能會導致受傷。

Notice 提示事項

1. Do not swing the baffle plate, otherwise the baffle plate may operate in inaccurate angles.
請勿用手調整導風板，否則可能會導致導風板無法按正確角度運轉。
2. The bathroom size may affect the heating performance of this product.
浴室大小的不同會影響本產品的暖房效果。
3. The applicable ambient temperature of this product is in the range of -10°C ~ 40°C , using it out of this range may cause a fault.
本產品適用環境溫度 -10°C ~ 40°C ，否則可能會引起故障。

MAINTENANCE

維護方法

Cleaning Precautions 清潔注意事項

Cleaning the louver: 面板組合的清潔:

1. To prevent color change and accelerated aging of the panel, do not use any type of diluent, alkaline cleaner, benzene, alcohol, antiseptic, or steel ball as shown below.
為避免導致面板變色及加速面板老化，請勿使用類似於圖示的各種稀釋劑、鹼性清潔劑、苯、酒精、殺菌劑或鋼絲球等。
2. To use a chemical cloth, clean this product by following the instructions.
如使用化學抹布，請遵照其使用指示來清潔本產品。



Cleaning the filter: 過濾網的清潔:

1. Do not wash the filter with water, because water may destroy the anti-microbial performance of the filter; do not use a wire brush or any other hard tool to clean the filter, lest the filter would be damaged.
不可用水洗，因為水會破壞過濾網的抗菌性能；不可用鋼絲刷或其他硬質的工具來清潔以免損壞過濾網。
2. When the filter cleaning indicator at the receiving part of the main body blinks, it is time to clean the filter. You need to clean the filter. (When the accumulated running duration reaches 2,200 hours (continuous running about three months), the filter cleaning indicator will blink.)
當機體接收部的過濾網清潔指示燈閃爍時，表示已達到清潔過濾網的時間，請清潔過濾網。(當運轉時間累計達到2200小時(約連續運轉3個月)，清潔指示燈就會閃爍。)

Cleaning the louver assembly and filter assembly 清潔面板組合和過濾網組合

- ① Shut off the all-pole switch.
斷開“電源全極開關”。
 - ② Wipe the front panel and the panel base with a soft cloth.
用軟布擦拭前面板及面板底座。
 - ③ Remove the filter assembly from the louver assembly.
將過濾網組合從面板組合中取出。
 - ④ Use a vacuum cleaner to remove dust from the filter assembly.
用吸塵機清除過濾網組合上的灰塵。
 - ⑤ Reinstall the filter assembly.
重新安裝過濾網組合。
- Notice
提示事項
- Be sure to install the filter, otherwise dust will enter the body.
請務必安裝過濾網，否則灰塵會進入機體。
- ⑥ Turn on the all-pole switch.
開啟“電源全極開關”。

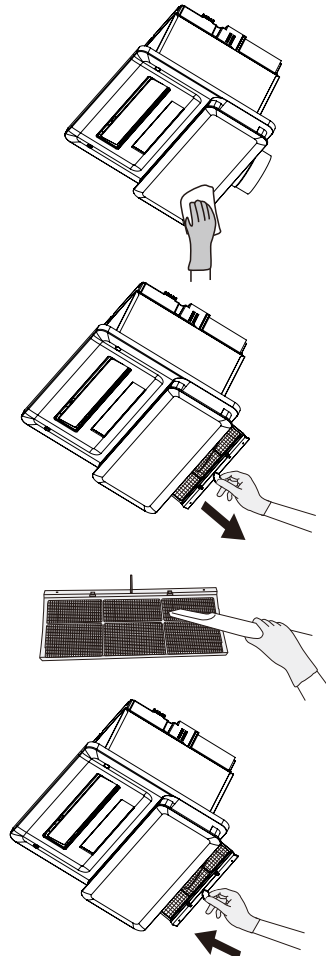

MAINTENANCE

維護方法

- ⑦ Clear the filter cleaning indication at the mode button panel on main body.

取消機體模式按鈕面板過濾網清潔提示。

Press and hold the MODE button at the mode button panel on main body for 3 seconds. After releasing the button, a “beep” means the filter cleaning indication is cleared. (The accumulated time of the filter cleaning indication will be reset, and the time will be accumulated again.)

長按機體模式按鈕面板模式按鈕3秒，放開後，聽到“嗶”的一聲，過濾網清潔提示將被解除。(過濾網清潔指示的累計時間將重新累計。)

- ※ Each time cleaning the filter, you are advised to reset the accumulated time of the filter cleaning indication. (Press and hold the MODE button for 3 seconds. After releasing the button, a “beep” sound means the resetting is done.)

每次清潔過濾網後，建議將過濾網清潔提示的累計時間復位。(長按模式按鈕3秒，放開後，聽到“嗶”的一聲，復位完成。)

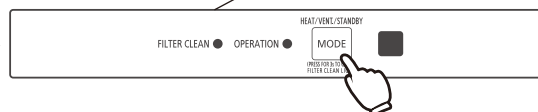
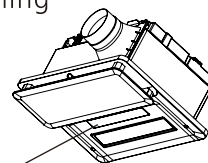

WIRING DIAGRAM

電氣原理圖

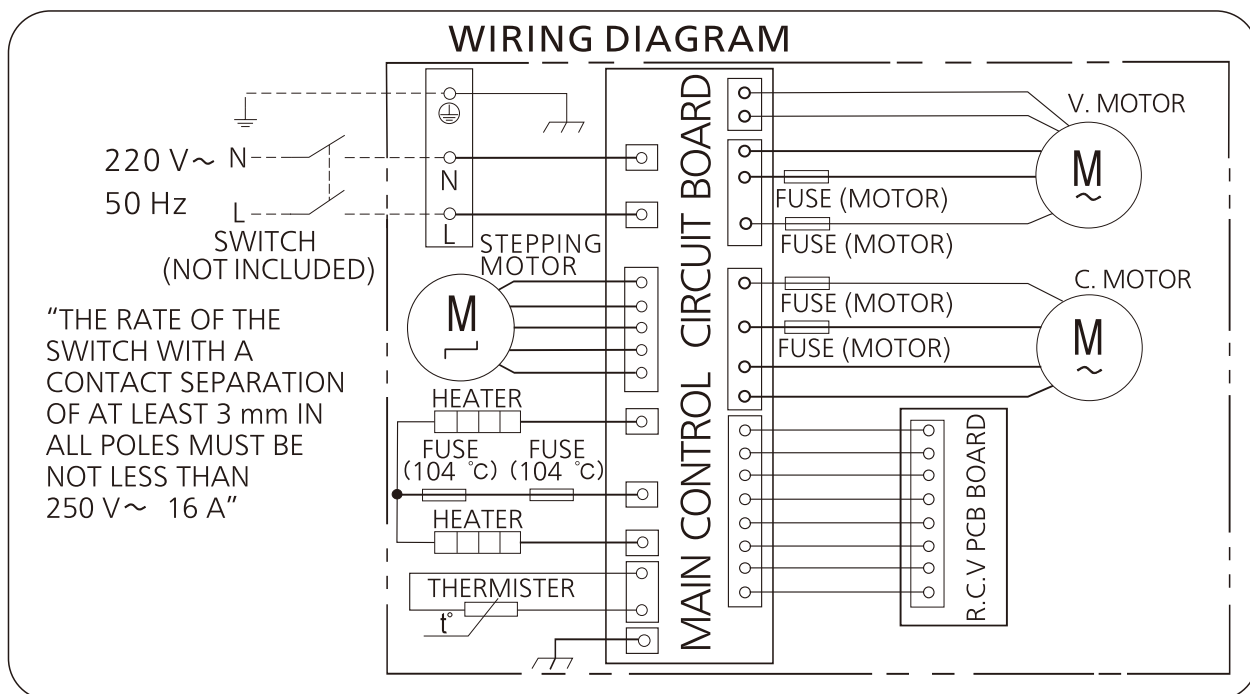

TROUBLESHOOTING

常見故障的識別與處理

Check the product according to the table below if a fault occurs. If an error still occurs, check that the all-pole switch connected to this product is disconnected, and contact customer consultation service center or your distributor.

發生故障時請按下表進行檢查，如果問題仍然未能解決，請確保連接本產品的“電源全極開關”處於斷開狀態，且與客戶諮詢服務中心或經銷商聯繫。

	Symptom 癥狀	Cause 原因	Troubleshooting 處理
Air 風	No hot wind blow out 無熱風吹出	The heater may fail 有可能是加熱器不良	Contact customer consultation service center or your distributor 請與客戶諮詢服務中心或經銷商聯繫
	Air volume reduced 風量變小	The filter may be blocked 有可能是過濾網堵塞	Clean the filter 請清潔過濾網
Remote control 遙控器	Remote control does not work 遙控器無法操作	The batteries may be exhausted 有可能是電池電量消耗完	Replace the batteries 請更換新電池
	Text display of the remote controller is dim 遙控器文字顯示不清晰		
	Remote controller display is unstable 遙控器顯示不穩定		
Mode button panel on main body 機體模式面板	The filter cleaning indicator blinks quickly 過濾網清潔指示燈快速閃爍	It's time to clean the filter 到達需清潔過濾網時間	Clean the filter 請清潔過濾網
	The running indicator blinks quickly 運轉指示燈快速閃爍	The product is error 產品運轉異常	Contact customer consultation service center or your distributor 請與客戶諮詢服務中心或經銷商聯繫

ANTIBACTERIAL FUNCTION

抗菌功能

- ※ The filter mesh in the filter mesh assembly provides the antibacterial function, with the antibacterial ratio against staphylococcus aureus and the antibacterial ratio against colibacillus up to 99.9 % respectively (test basis: JIS Z2801).
- ※ After using for a period of time, the colour of the filter mesh will change from yellow to brown, but the changing material colour will not affect performance.
- ※ As the use time increases, the antibacterial performance of the filter mesh will decrease accordingly.
- ※ 過濾網組合中的過濾網具有抗菌功能，其對金黃色葡萄球菌抗菌率達到99.9%，大腸桿菌抗菌率達到99.9%。（檢測依據：JIS Z2801）。
- ※ 使用一段時間後，過濾網的顏色會從黃色變成茶色，這種材質顏色的變化並不影響性能。
- ※ 隨著使用時間的增加，過濾網的抗菌性能會相應減弱。

SPECIFICATIONS

規格

Model No. 型號	Rated voltage 額定電壓 [V]	Rated frequency 額定頻率 [Hz]	Power consumption 額定輸入總功率 [W]	Rated current 額定電流 [A]	Air volume 換氣風量 [m ³ /h]		Weight 淨重 [kg]
					Hi 強	Low 弱	
40BECH	220	50	2650	12.1	220	90	7.6

Power Consumption 功率 [W]						Noise 噪音 [dB(A)]					
Heat 暖氣		Dry 乾燥		Vent 換氣		Heat 暖氣		Dry 乾燥		Vent 換氣	
Hi 強	Low 弱	Hot 熱	Cool 涼	Hi 強	Low 弱	Hi 強	Low 弱	Hot 熱	Cool 涼	Hi 強	Low 弱
2650	2490	2650	39.2	29	15	45	38	45	45	42	24

- Power consumption and rated current are obtained when the product is under 90°. 額定輸入總功率、額定電流值在導風板處於90°狀態下測得。
- Air volume, electric specification and noise value are measured when static pressure is 0 Pa. 換氣風量、電氣特性、噪音值等數據是在靜壓為0 Pa狀態下的數值。
- Noise value is the weighted sound pressure grade A, which is the central value measured by this company, its tolerance range is from +3 dB to -7 dB. The method to measure is as follows: in an anechoic chamber, measure noise value first 1 m away from the left, right and beneath of the sample, then get the averaged value.
噪音值為A計權平均聲壓級，是本公司測試結果的中心值，有+3 dB，-7 dB的公差範圍。測試方法為在全消音噪聲測試室內，距樣品左側、右側、下方各1米處測定其噪音值，然後取其平均值。
- Air volume is the central value measured by this company with ±10% of tolerance range. 換氣風量是本公司測試結果的中心值，有±10%的公差範圍。
- This product comply with the IPX2 requirement against the water drop test and its remote control comply with the IPX4 requirement against the water shower test.
本產品機體通過防水試驗，符合IPX2要求，遙控器通過防濺水試驗，符合IPX4要求。
- Insulation class E
E級絕緣

The above specification may be changed without further notice.
上述參數如有變動，恕不另行通知。

CHECKS AFTER INSTALLATION

安裝後檢查

Check the following items before trial operation.

Be sure to put a tick mark in the corresponding tick box .

Perform trial operation after making these checks.

運轉試驗前請檢查以下項目。

務必在相應的勾選框中打上勾號.

請先進行這些檢查，然後再執行運轉試驗。

- (1) Product installation check / 產品安裝檢查 Reference page / 參考頁次
- Is the main unit installed securely, without looseness? Page 11
主機是否安裝牢固，沒有鬆動？ 第11頁
 - Are the product inlet and outlet kept unblocked? Page 17
產品進風口和出風口是否暢通無阻？ 第17頁
 - (Method 1 & 2) Is the self-tapping screw $\phi 4 \times 8$ fixed the adapter from inner? ... Page 11, 12
(方法一及二) 自攻螺絲 $\phi 4 \times 8$ 是否從機內側打入？ 第11, 12頁
 - (Method 1 & 2) Are the three self-tapping screws $\phi 4 \times 13$ fixed the main body in a proper direction? Page 11, 12
(方法一及二) 自攻螺絲 $\phi 4 \times 13$ 是否打在正確位置上？ 第11, 12頁
- (2) Electrical work check / 電氣作業檢查
- Is an earth leakage circuit breaker installed in the power supply? Page 8
電源是否安裝了漏電保護開關？ 第8頁
 - Is a 220 V AC single-phase used for the power supply? Page 4, 29
是否使用了220 V AC單相電源？ 第4, 29頁
 - Is the wiring connected according to the wiring diagram? Page 9
配線是否按照配線圖進行連接？ 第9頁
 - Are the power cable connected to the terminal block without looseness? Page 10
連接到接線盒的電源線是否鬆動？ 第10頁
 - Is the connected wiring secured with cable clips? Page 10
連接的配線是否用線夾固定？ 第10頁
 - Is the earth connected? Page 2, 10
是否接地？ 第2, 10頁
 - Is there enough spare in length for power cord (for easy installation, removal and maintenance)? Page 7
連接機體的電源線有否預留足夠長度 (以便於安裝、拆卸與維護)? 第7頁
- (3) Others / 其他
- Is there any air leakage from the joint between the duct and the adapter? Page 15
確保管道裝上出風口接頭上沒有漏風？ 第15頁
- *To prevent initial problems, be sure to perform the post-installation checks before hand-over to the customer.
*為防止出現早期問題，請務必在交付給客戶之前執行安裝後檢查。